

## User Manual

# CARLO Alu Comfort EP 185 & Classic 185



Article number: 924003100, 924002008, 924002018, 924003200, 924003208, 924003218,  
925006000, 925006008, 925006018

Dear Customer,

Thank you for purchasing this BEKA Hospitec GmbH product. Our products are manufactured and tested according to stringent quality criteria. A correct use of the device is imperatively in order to ensure its proper and safe functioning. Please read the content of this operating manual before starting to use the product.

Please observe the safety instructions in particular!



Please note that there might be minor differences between the images shown in this manual and the actually supplied device.

Subject to technical modifications and error.

Should you have any questions or require more information about your device, please contact us by phone either by fax.

Our collaborators will be glad to help you.



BEKA Hospitec GmbH is certified according to DIN EN ISO 9001 and DIN EN ISO 13485 by TÜV SÜD Product Service GmbH.

Therefore, the development, manufacturing, quality assurance and service of our entire product range is subject to high quality standards.

**Table of contents**

**1. Introduction ..... 6**

**2. Symbols and pictograms used in this manual ..... 7**

2.1 Type plate ..... 8

2.2 Designation ..... 8

**3. Unpacking and Assembling ..... 9**

3.1 Required Tools..... 9

3.2 Removing the Cardboard ..... 9

3.3 Releasing from the Pallet ..... 9

**4. Installation ..... 10**

4.1 Electrical Connection for Power Cable and Wall Charging Unit ..... 10

4.2 Installation ..... 10

4.3 CARLO Alu Electrical Connection ..... 10

4.4 Start-up and Operation (electrical motor/battery unit)..... 10

**5. Variants ..... 12**

5.1 CARLO ALU Variants..... 12

5.2 Spreader Bar Variants..... 12

**6. Operation of the CARLO Alu ..... 13**

6.1 Fields of Application ..... 13

6.2 Duration of Treatment ..... 13

6.3 Contra-indications ..... 13

6.4 Safety instructions ..... 14

**7. CARLO ALU Operating Elements ..... 17**

7.1 Classic Spreader Bar Version ..... 18

7.2 Handset..... 18

7.3 Explanation of the LED-indications on the Handset ..... 19

7.4 Connections and Functions of the Control Unit ..... 19

7.4 24V-Battery Unit ..... 21

7.5 External Charging Unit/Wall Charging Unit ..... 21

7.6 Manual Emergency Lowering System ..... 23

7.7 Electrical emergency lowering ..... 23

7.8 Emergency stop switch ..... 24

7.9 Motor Safety Measures ..... 25

7.10 Impact and Jamming Protection (hoist motor) ..... 25

7.11 Contact Persons for Technical Information ..... 25

<b>8.</b>	<b>Sling Operating Manual .....</b>	<b>26</b>
8.1	Prior to Use .....	26
8.2	During Use .....	26
8.3	After Use .....	28
<b>9.</b>	<b>Applying the BEKA Hospitec Sling in Sitting Position .....</b>	<b>29</b>
9.1	Applying the BEKA Sling in Lying Position .....	29
9.2	Manual for the Toilet Sling.....	30
<b>10.</b>	<b>Operation of the CARLO ALU.....</b>	<b>31</b>
10.1	Explanation of the Functions of the Handset.....	31
10.2	Lifting a patient/resident .....	32
10.3	Putting the patient/resident down .....	33
<b>11.</b>	<b>Digital scale SLS (option) .....</b>	<b>34</b>
11.1	Safety Instructions Digital Scale SLS .....	34
11.2	Cleaning of the Scale .....	34
11.3	Instructions.....	34
11.4	Putting the Scale into Operation.....	35
11.5	Tarring/Adding.....	36
11.6	Unit Conversion (kg < - > Lb.) .....	38
11.7	Filter Setting/Modification (Stabilization of the Weight Display).....	40
<b>12.</b>	<b>Maintenance and Care of the 24-Volt Battery .....</b>	<b>41</b>
12.1	Contact Persons for Technical Information .....	41
<b>13.</b>	<b>Cleaning/Disinfection.....</b>	<b>41</b>
13.1	Cleaning of the CARLO ALU Sling Hoist.....	41
13.2	Disinfecting the CARLO ALU.....	42
13.3	Sterilization.....	42
<b>14.</b>	<b>Waste Disposal.....</b>	<b>42</b>
14.1	Disposal of the Packaging Material .....	42
14.2	Disposal of the Product .....	42
<b>15.</b>	<b>Prescribed Inspections &amp; Checks.....</b>	<b>43</b>
15.1	Prior to each use .....	44
<b>16.</b>	<b>Troubleshooting and After-sales Service .....</b>	<b>45</b>
16.1	Help for Troubleshooting .....	45
16.2	After-sales Service .....	46
<b>17.</b>	<b>Appendix .....</b>	<b>47</b>
17.1	Technical Data .....	47
17.2	Manufacturer .....	48

17.3	Dimensions CARLO ALU, Classic / EP .....	49
17.4	Declaration of Conformity .....	50
17.5	Accessories of the Sling Hoists CARLO Alu Classic 185Kg.....	51
17.6	Accessories CARLOAlu Comfort EP 185 .....	53
<b>18.</b>	<b>Mounting instructions.....</b>	<b>56</b>
18.1	Rear Castor Replacement.....	56
18.2	Front Castor Replacement .....	57
18.3	Control including Handle, Mounting Plate and Battery Compartment.....	58
18.4	Replacing the Battery .....	61

## 1. Introduction

Dear Customer,

Please observe the following:

1. Please read the provided operating manuals carefully and thoroughly.
2. Use the device only for the intended application.
3. The device may only be operated by trained staff.
4. Electrical installations are to be carried out by specialist companies only, in accordance with the currently applicable VDE-regulations (German association of electricians).
5. Servicing, maintenance operations and safety checks may only be performed by either BEKA Hospitec or by qualified staff trained by BEKA Hospitec.
6. Assembly operations, extensions, modifications, or repairs may only be performed by either BEKA Hospitec or by specialist companies authorized by BEKA Hospitec.

In case of technical interventions, such as extensions and fittings to our devices, which are not carried out by BEKA Hospitec either by specialist companies authorized by BEKA Hospitec, all warranty rights on the modifications as well as on the device or on the device functions, which are related to the modification, shall expire.

## Liability and warranty

The manufacturer of the device is only responsible for the safety and the reliability of the device, if:

- a. the installation has been carried out by authorized staff
- b. the space concerned complies with the current VDE-regulations

and if the following conditions are met:

- c. the device is only used as per the intended purpose
- d. the functional tests are performed periodically

Manufacturer contact details:



BEKA Hospitec GmbH  
Am Rübenmorgen 3 • 35582 Wetzlar  
Phone: +49(0)641-9 22 20 - 0  
Fax: +49(0)641-9 22 20 - 20  
info@beka-hospitec.de  
www.beka-hospitec.de



## 2. Symbols and pictograms used in this manual



Please observe the accompanying documents/operating manual.



Warning Hazardous Area.



Applied part "Type B" to DIN EN 60601-1.



Do not push/pull the motor.  
Do not push/pull the spreader bar.



Special waste, no household waste.  
The device and the packaging materials never must be disposed of in the domestic waste stream.



CE-label in accordance with the EC-Directive on Medical Devices.



Solely intended for indoor use.



Protection class II.



Washing temperature max. 60 °C.  
Normal cycle.



Do not bleach.



Line dry



Do not tumble dry.



Do not iron.



Professional wet clean.  
Gentle cycle.

## 2.1 Type plate

  <p>BEKA Hospitec GmbH Am Rübenmorgen 3 D- 35582 Wetzlar Tel: +49 (0) 641 / 92 22 0 - 0 Fax: +49 (0) 641 / 92 22 0 - 20 www.beka-hospitec.de</p> 	
Type:	<p><b>CARLO Alu</b></p>  <p>2016-14</p>
<p><b>SN</b> 1416124078</p> <p><b>REF</b> 925006000</p>	
<p>Operating Voltage: <b>24 V DC</b></p>	<p>Max Patient weight: <b>185 kg / 408 lbs</b></p>
<p>Power Consumption: <b>Max. 240VA</b></p>	<p>for charging use only BEKA- charger <b>Art.-No.: 921070702</b></p>
<p>short- term operation</p>	<p>6 double strokes      25 min <b>OFF</b></p>

This image shows the type plate.  
The type plate is located at the column support of the sling hoist.  
The shown serial number (**SN**) 1416124078 is just an example.  
In case of queries, please mention the serial number printed on the type plate of your stand-up and raising aid.

**Note:** Because of legal regulations, it might be required that the article number and the serial number should be computer-readable as well and therefore they might be printed on the type plate as well in the form of a barcode.

## 2.2 Designation

The different types described in this instruction manual (4-point spreader bar, Classic 6-point spreader bar, Classic and Comfort EP) are variations of “CARLO Alu”.

Any differences in use are given through extra references.



### 3. Unpacking and Assembling

#### 3.1 Required Tools

To remove the packaging materials, you will need:

Cutter knife



#### 3.2 Removing the Cardboard

Cut the strap with the cutter knife and remove the strap.

**Note: Do not cut in the cardboard, as this could damage the surface of the CARLO Alu**



Lift the cardboard up to remove it and put it aside.

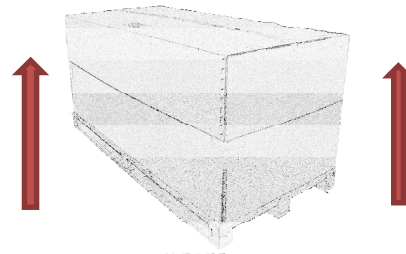

#### 3.3 Releasing from the Pallet

CARLO Alu

Both sides of the CARLO Alu are strapped to the pallet.

Remove the screws and the straps. Please take care not to damage the CARLO Alu when unscrewing the screws.

Please make sure that the brakes of the castors are released.



Brake

After all fixations have been removed, you can remove the CARLO Alu from the pallet.

Remove the bubble wrap and the stretch film. Please take care not to damage the surface of the CARLO Alu with the tools.

The accessories for your CARLO Alu are included in the supplied cardboard box.

## 4. Installation

Dear Customer,

- Before you start to use our products, your electrical installation must be checked in accordance with the relevant VDE-regulations 0100 and 0100-710.  
This requirement is only applicable in Germany.  
In other countries, other requirements might be applicable.  
Ask a qualified electrician to install the wall charging unit in accordance with the regulations applicable in your country.

### 4.1 Electrical Connection for Power Cable and Wall Charging Unit

The socket must meet the requirements of VDE 0100 and 0100-710.

### 4.2 Installation

The CARLO Alu is supplied ready for use.

### 4.3 CARLO Alu Electrical Connection

The CARLO Alu is equipped with a 24V-battery system. A power connection, which is compliant to the VDE regulations, is required for the charger cable as well as the wall charging unit. In operation, the CARLO Alu is mains-independent.

### 4.4 Start-up and Operation (electrical motor/battery unit)

The CARLO Alu is equipped with a 24V-electrical motor. This motor is self-locking and therefore protected against unintentional lowering of the spreader bar in case of malfunction or failure. The battery of the CARLO Alu must be completely charged before starting to use the device. Please check that the emergency stop switch is released (unlatched). To unlatch, turn the emergency stop switch clockwise until it releases.

**NOTE:**

The battery must be completely charged prior to the first use of the CARLO alu (charging time approx. 4 hours).

Please check that the emergency stop switch is released prior to moving the spreader bar.

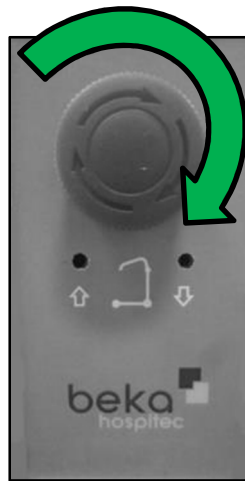

The emergency stop switch is released by turning the button to the right (i.e. clockwise).

## 5. Variants

### 5.1 CARLO ALU Variants

Article number	Description	Spreader bar
924003100	CARLO Alu, Classic 185	4-point spreader bar
924002008	CARLO Alu Classic 185	4-point spreader bar
924002018	CARLO Alu Classic 185	4-point spreader bar
924003200	CARLO Alu Classic 185	6-point spreader bar
924003208	CARLO Alu Classic 185	6-point spreader bar
924003218	CARLO Alu Classic 185	6-point spreader bar
925006000	CARLO Alu Comfort EP 185	4-point EP spreader bar
925006008	CARLO Alu Comfort EP 185	4-point EP spreader bar
925006018	CARLO Alu Comfort EP 185	4-point EP spreader bar

### 5.2 Spreader Bar Variants



Classic version 4-point spreader bar



EP version, 4-point spreader bar



Classic version 6-point spreader bar  
with optional scale

## 6. Operation of the CARLO Alu

### 6.1 Fields of Application

The CARLO ALU has been designed for transferring residents in hospitals, nursing homes, care centers and facilities for the disabled. The resident can be lifted from a lying or sitting position or even from the ground. The CARLO ALU is to be used exclusively for the indoor transport of residents on smooth and level floorings.

### 6.2 Duration of Treatment

The CARLO ALU is designed for a short-term use and any contact with injured skin must be avoided.

#### **Note**

No side effects associated to the treatments are known.  
Please observe the contra-indications mentioned in Paragraph 6.3.

### 6.3 Contra-indications

#### **WARNING:**



Residents suffering from:

- Osteoporosis
- Spine disorders/spinal damage
- Osteogenesis imperfecta
- Mental confusion
- epileptic attacks

may only be treated with the CARLO ALU in consultation with the attending physician.

Please observe also the safety instructions listed in the following paragraph.

## 6.4 Safety instructions

Please read the following safety instructions prior to using the CARLO ALU. All notes, specifications and warnings mentioned on the device as well as in the present operating manual must be imperatively respected and observed.

The manufacturer BEKA Hospitec GmbH shall **not** accept any liability for any damages, failures or faults caused by improper operation or handling.

- **Operating manual** 
  - Please read the operating manual and the safety instructions before starting to use the CARLO ALU. Keep the operating manual near the device for future reference.
  - The CARLO ALU may only be used for the specified purpose.
  - In case of unusual noises, damages or malfunctions, the CARLO ALU no longer must be used.
  - The product may only be used and operated by trained staff.
  - Check prior to each use that all visible parts are intact. Do not use the CARLO ALU if any part is damaged.
  - The product must be disinfected after each use.
  - Avoid slippery surfaces and thresholds.
  - Do not move the CARLO ALU over sloping or uneven floors.
  - The CARLO ALU is exclusively fit for indoor use.
  - Prior to each use of the device and its accessories, the user must check the functional safety and the good condition of the device and its accessories (e.g. visual check, functioning, etc.).
  - Supervision of the caregiver is required throughout the treatment.
  - Make sure that the sling form and size match the resident's body.
  - Check prior to lifting that all clips or loops are correctly fixed to the spreader bar.
  - Only trained staff is authorized to use slings.
  - Please respect and observe the size and weight specifications for each sling.
  - Check prior to each lifting operation whether the help of a second assistant is required.
  - Each lifting or transport procedure must be adequately planned in order to ensure an optimal protection for the caregiver and the resident.
  - Please check before and during the height adjustment procedure that your feet are not located in the area of the castors neither in the resident's area.
  - Do not stand between the CARLO ALU and an obstacle during the transport procedure.
  - During the movement of the CARLO ALU, the carrier frame must be closed.
  - Please check that no one grabs in the hazardous areas (spreader bar, carrier frame) especially during the adjustment procedure - risk of crushing.
  - Make sure that the resident is not hurt by the door frame when passing through doors.
  - Do not lift the resident higher than is necessary.

- Engage the parking brakes of the wheelchair's castors etc. to ensure a safe lifting and positioning of the resident. The brakes of the CARLO ALU must be activated (locked) until the resident has been positioned safely.
  - Activate the brakes of the castors of the wheelchair, the healthcare bed, the stretcher, etc. to ensure a safe lifting and positioning of the resident. The brakes of the CARLO ALU must be unbraked (released) during this operation.
  - Keep the transport of the resident as short as possible and never leave the resident unattended in the sling.
  - Never tilt or pull the resident beyond the fixing point of the spreader bar.
  - Never exceed the duty cycle or the maximum load.
  - Make sure that the battery is charged in a well-ventilated room.
  - Do not use the CARLO ALU when the battery is charging.
  - Make sure that the resident crosses the arms on the chest instead of holding on to the spreader bar.
  - When applying the sling, make sure that the spreader bar does not touch the resident's head.
  - Check the applied sling for visual damages prior to using it.
  - Move the CARLO ALU by means of the handles provided to that effect instead of pulling the spreader bar.
- **Ventilation**  
Never cover up, over sticker or change the slots and holes of the device.
  - **Customer service**  
Should the CARLO ALU be defect and the problem cannot be resolved by means of one of the measures described in section 15, please contact the customer service of your BEKA dealer either the manufacturer:

**BEKA Hospitec GmbH**

Am Rübenmorgen 3 • 35582 Wetzlar

Phone: +49(0)641-9 22 20 - 0

Fax: +49(0)641-9 22 20 - 20

info@beka-hospitec.de

www.beka-hospitec.de

- **Cleaning**  
Do not use any aerosol cleaner to clean the CARLO ALU.
- The caregivers must protect their skin and eyes against concentrated disinfecting and cleaning products.

**Please respect and observe the manufacturer's specifications for the disinfecting agent used!**

Instructions for cleaning and disinfection can be found in section 12.



- **Repairs**

Repairs to components of the CARLO ALU are to be carried out only by trained expert personnel. Please contact the after-sales service.

Opening the device or other accessories will lead to the expiration of all guarantee, warranty and liability claims.

- **Duty of care**

Please check the proper state and the functional safety of the system prior to use. Never insert foreign bodies in the device.

- **Safety checks**

The CARLO ALU is subject to a 12-month “safety check” (SC). The intervals are fixed in section 15.

- In order to preserve the value of the device, we recommend an annual maintenance of the CARLO ALU.

- **Accessories**

Use only original accessories for the CARLO ALU sling hoist.

**WARNING:**

Any unauthorized repairs, reconstructions and modifications/alterations are not permitted for safety reasons and shall exclude all liability of the manufacturer for the resulting damages.

For damages resulting from the use of spare parts or accessories, which are not authorized by the manufacturer, any further liability of the manufacturer shall be excluded.

- **Applied part**



The CARLO ALU is equipped with “B”-Type applied parts.

All exposed, touchable, conductive parts are thereby considered as applied part.

## 7. CARLO ALU Operating Elements

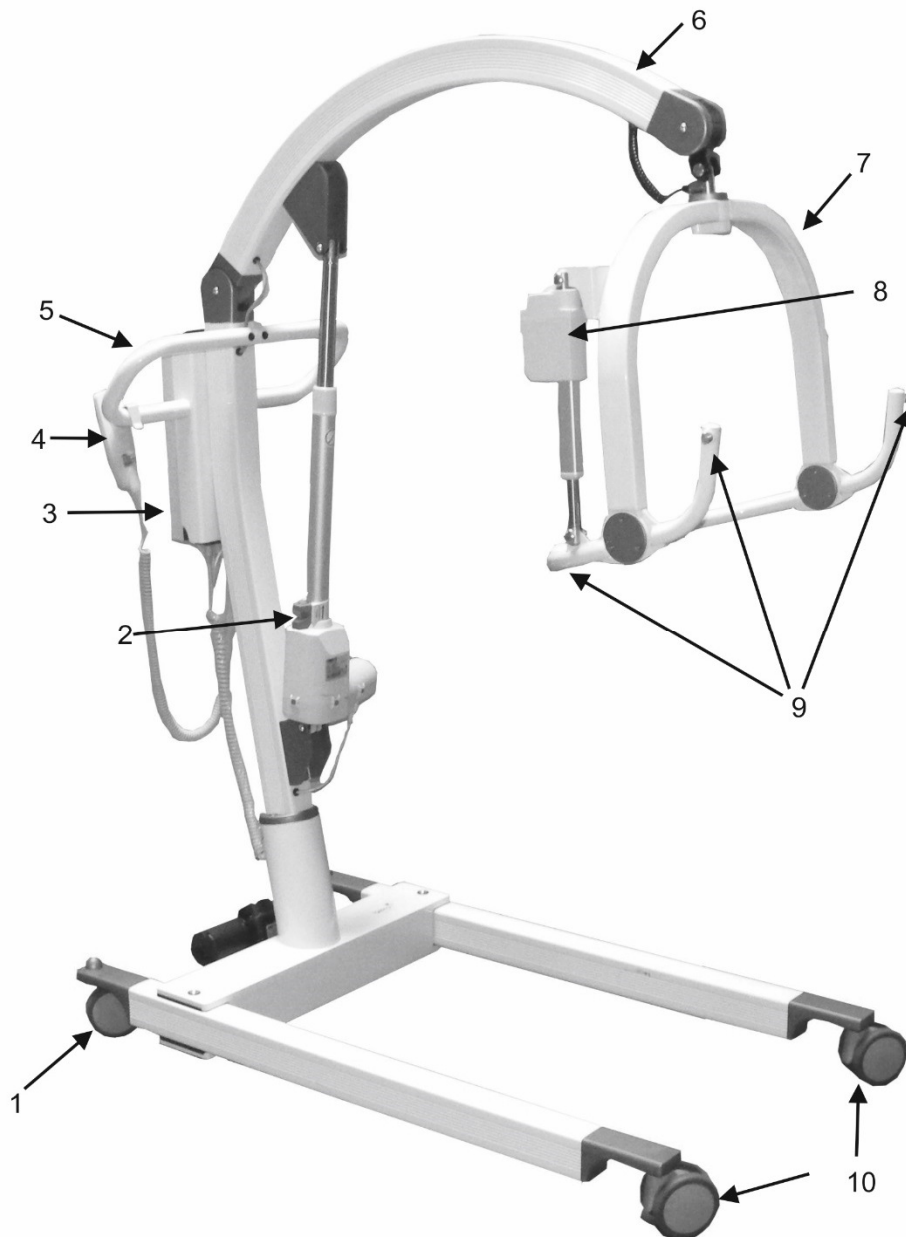

N°	Description	N°	Description
1	Rear castors with brake	6	Arm
2	Emergency lowering system	7	Spreader bar
3	Control unit with battery	8	Motor for the spreader bar adjustment (only EP)
4	Handset	9	Attachment point only for slings with clips <b>Caution: no slings with loops</b>
5	Spreader bar	10	Front castors

## 7.1 Classic Spreader Bar Version

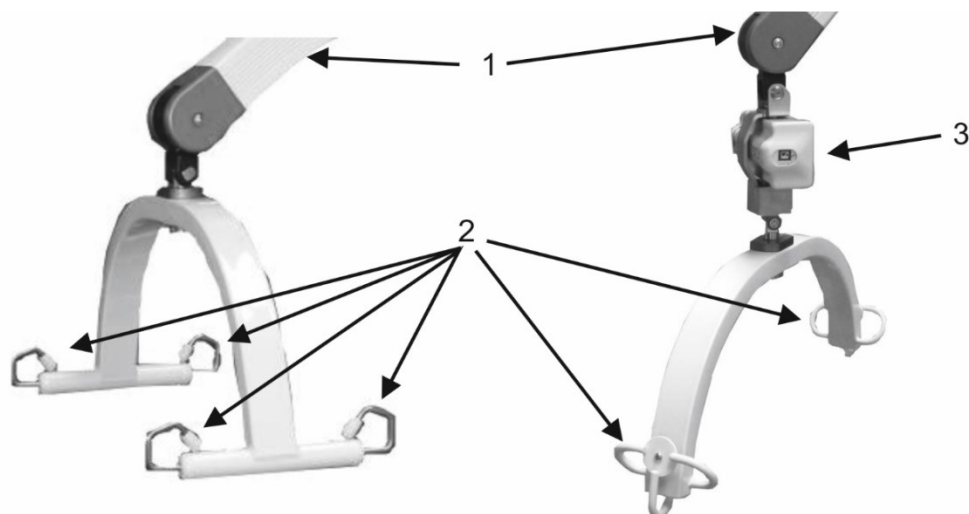

N°	Description	N°	Description
1	Arm	3	Scale, optionally available
2	Attachment points for slings with loops <b>Caution: no slings with clips</b>		

## 7.2 Handset

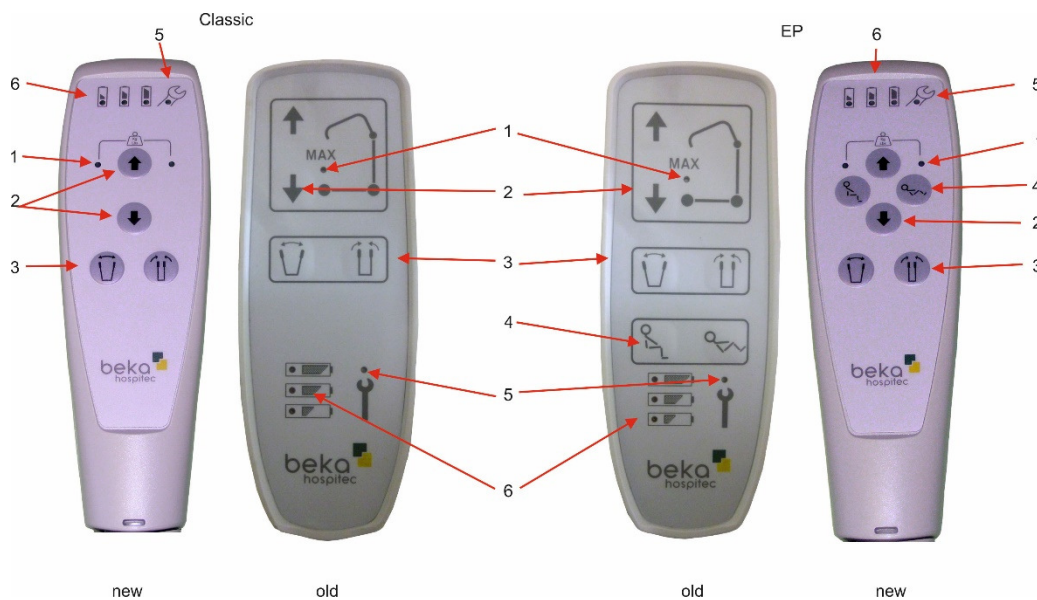

N°	Description	N°	Description
1	Overload	4	Only EP spreader bar, sitting and lying function
2	Spreader bar up/down	5	Service indication
3	Spreading the carrier frame	6	Battery charge level indication

### 7.3 Explanation of the LED-indications on the Handset



Green LED: battery full, no charging required (100-50%)



Yellow LED: battery requires charging (50-25%)



Red LED: battery requires charging (less than 25%)

When you push a button, an audible signal will be emitted.



Service indication (orange LED flashes).

Please have your stand-up and raising aid checked!



Orange LED, overload, max. weight of 230 kg exceeded

### 7.4 Connections and Functions of the Control Unit

#### 7.3.1 European Control Unit

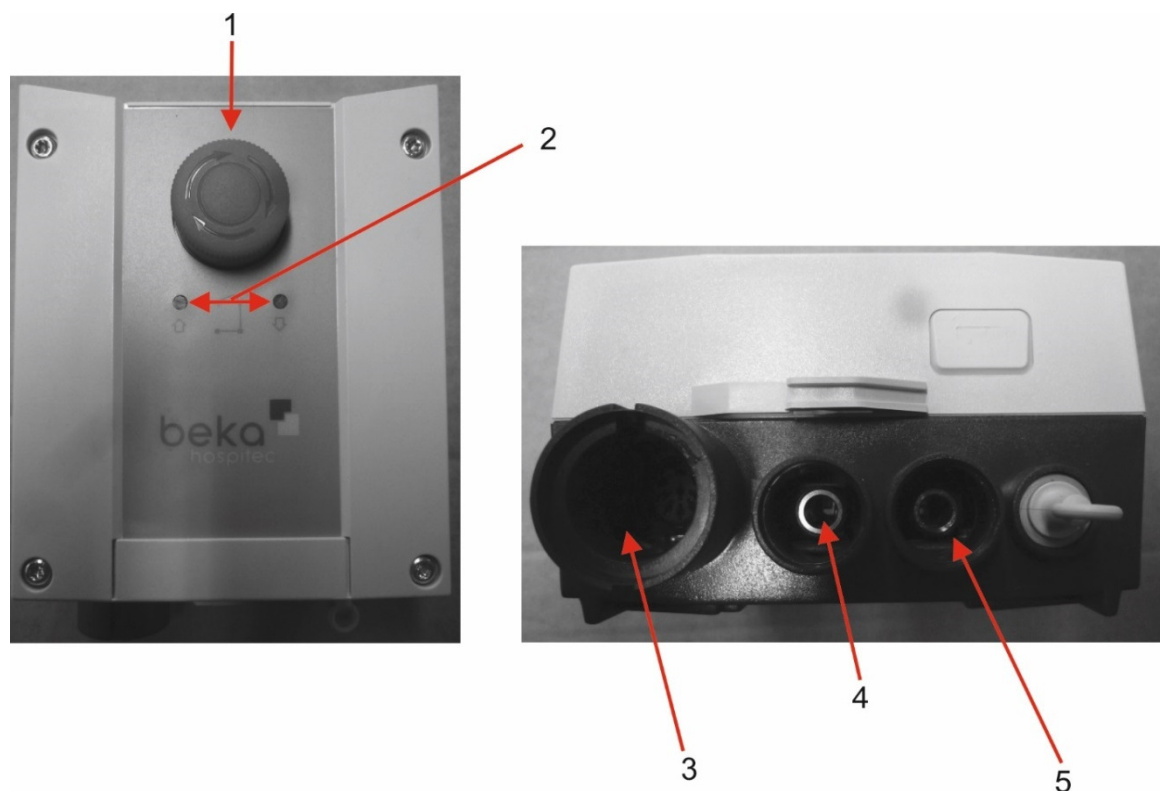

N°	Description	N°	Description
1	Emergency stop switch	3	Handset connection
2	Electrical emergency lowering (in case of malfunction of the handset)	4	Lifting motor connection
		5	Spreading motor connection

### 7.3.2 Canadian Control Unit

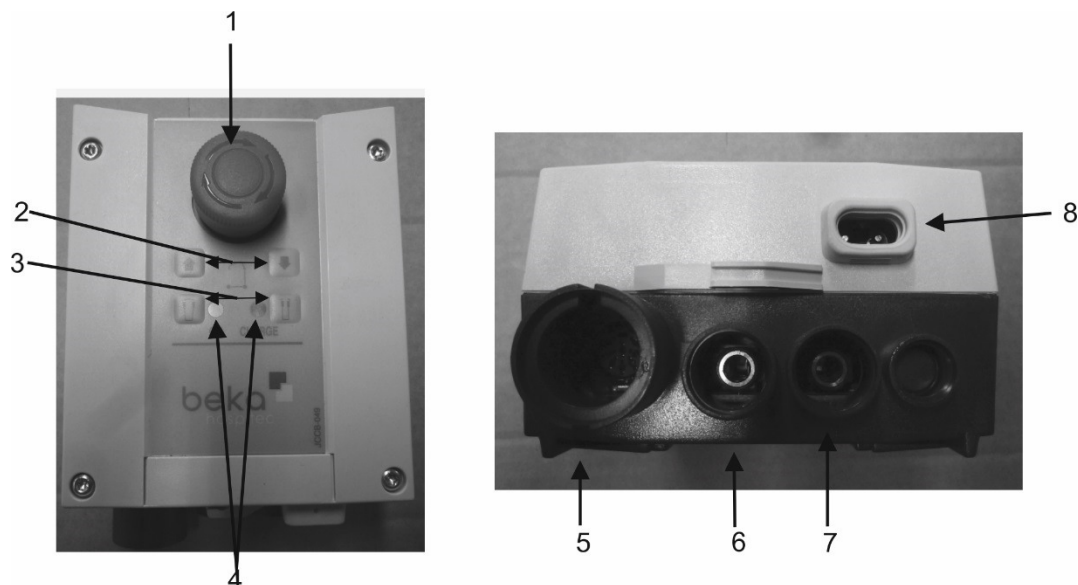

N°	Description	N°	Description
1	Emergency stop switch	5	Handset connection
2	Electrical emergency lowering (in case of failure of the handset)	6	Lifting motor connection
3	Adjustment of the spreading (in case of failure of the handset)	7	Spreading motor connection
4	Power and charging indicator	8	Charger cable connection

#### Explanation of the LED-indications



Green LED

The LED is on when the control unit is supplied with voltage through the power cable.



Yellow LED

The LED is on when the battery is charging.

Note: The battery can only be charged if the emergency stop switch is not actuated!

### 7.4 24V-Battery Unit

The CARLO ALU is equipped with a 24V-battery.  
Please proceed as described in par. 18.4 to remove the battery.



### 7.5 External Charging Unit/Wall Charging Unit

The external charging unit (wall charging unit) is a switch-mode charger and is supplied ready assembled (on a mounting rail). It can be installed on any suitable wall. The required power cable is included in the delivery.  
The charging time for the battery units is approx. 4 hours.

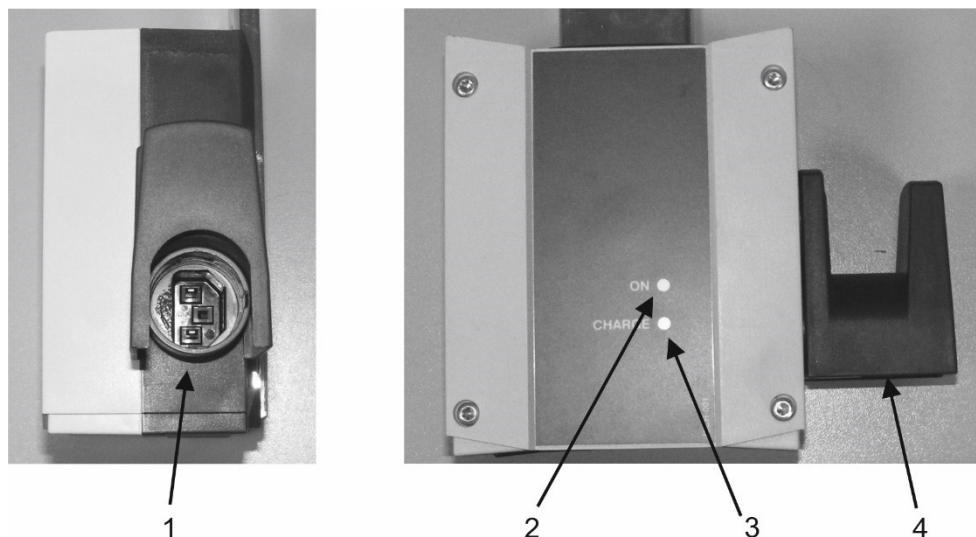

N°	Description	N°	Description
1	Mains input socket	3	Charging indicator (yellow LED)
2	Mains operation indicator (green LED)	4	Cable holder (optionally)

#### Explanation of the LED-indications



Green LED

The LED is on when the control unit is supplied with voltage through the power cable.



Yellow LED

The LED is on when the battery is charging.



## 7.6 Manual Emergency Lowering System

**Emergency Lowering System**

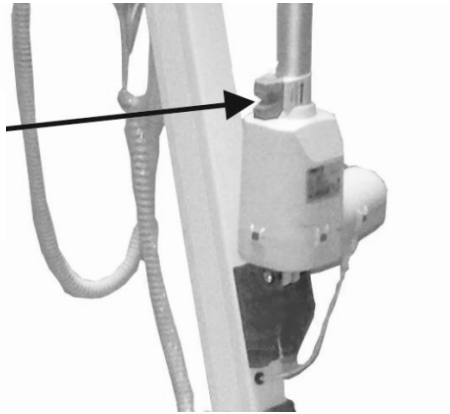

### Activating the Emergency Lowering System:

1. Slide the red safety lock upwards in the direction of the arrow (PULL-EMERGENCY label).
2. Now, the motor is lowering slowly (lowering weight approx. 20 kg).
3. The motor stops, when the safety lock is positioned back in its normal position = release the safety lock.

### Note:

The emergency lowering mechanism must not be treated with oil, grease or any other lubricant, as this could cause the emergency lowering mechanism to run too smoothly! In case of a failure of the emergency lowering system, a reset at the manufacturer's is required.

## 7.7 Electrical emergency lowering

Should your handset be defective or present a malfunction and provided that the battery still has sufficient voltage, you can raise or lower the spreader bar by means of the buttons located on the control unit.

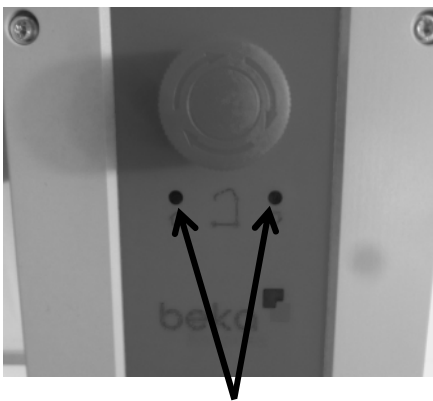

Buttons of the control unit (European version)

Insert a ballpoint or a similar object into the holes to actuate the buttons. The spreader bar is raised or lowered.

**Note:**

The buttons of the Canadian version of the control unit can be activated manually.

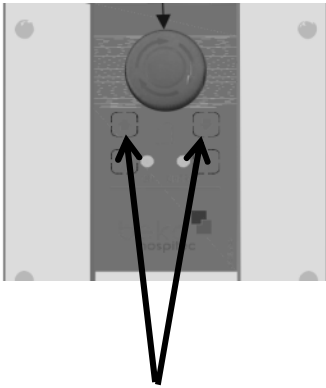

Buttons of the control unit (Canadian version)

### 7.8 Emergency stop switch

When the emergency stop switch is pressed, the electrical motors are immediately disconnected from the power supply. The motor stops immediately. The emergency stop switch should be used only in case of immediate danger to the resident or the caregivers.

The emergency stop switch can also be used to reduce discharging of the battery in case of intermediate storage.

By pressing the emergency stop switch, you can lock the CARLO ALU sling hoist, thus making any unauthorized use of the sling hoist more difficult.

Turn the button in the direction of the arrow to unlock.

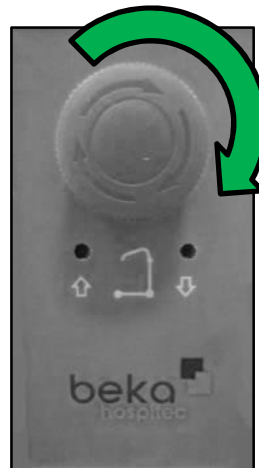
**NOTE:**

**In the Canadian version of the control unit, the battery can only be charged when the emergency stop switch is not actuated!**

## 7.9 Motor Safety Measures

The control of the electrical motor is equipped with an overload protection, which is autonomously switched off in case of overload. The motor will only be operational again after a short waiting time. The cooling-off time of the motor can be up to 18 minutes depending on the ambient temperature.

**NOTE:**

**Opening the motor will result in expiration of the warranty.**  
**The intermittent operation of the motor is not a defect, but is only for your own safety.**

## 7.10 Impact and Jamming Protection (hoist motor)

The electrical motor (hoist motor) features an integrated impact and jamming protection (freewheeling). This feature avoids jamming, pinching and/or crushing dangers when the spreader bar of the CARLO ALU strikes or encounters an obstacle. The motor runs free until the obstacle is removed or the CARLO ALU is moved away from the obstacle.

After the obstacle has been removed, the spreader bar could start lowering autonomously.

Therefore, you must immediately release the button of the handset as soon as you have noticed that an obstacle has been encountered.

## 7.11 Contact Persons for Technical Information

For technical information and in case of questions regarding the use of your sling hoist, please contact your dealer or the manufacturer:



BEKA Hospitec GmbH  
Am Rübenmorgen 3  
35582 Wetzlar  
Phone: +49(0)641-9 22 20 - 0  
Fax: +49(0)641-9 22 20 - 20  
info@beka-hospitec.de  
www.beka-hospitec.de

---

## 8. Sling Operating Manual

### Important note:

The normal service life of BEKA-slings is approx. 36 months from the date of production (marked on the sling). The specified service life is only applicable, when the BEKA-slings are cleaned, maintained and inspected in accordance with the instructions contained in the following documentation.

### 8.1 Prior to Use

The slings must be checked before and after each use and, if necessary, be washed in accordance with the manual. This is prescribed in particular to reduce the risk of infections to an absolute minimum, in the event that the same equipment is used for other residents or patients.

Prior to each use, a thorough check of the sling including the loops and the fastening clips is imperatively required. If the sling or the loops would be frayed, cut-in or damaged, or the clips would be damaged, the sling no longer must be used.

Please make sure that a sling of the correct size is used for the resident.

Prior to lifting the patient or the resident, the situation must be assessed by a qualified employee or a therapist. This also applies to care-dependent persons with limited or reduced shoulder mobility or for patients who are unable to hold themselves with one or both hands.

### 8.2 During Use

Check that the sling fittings at the sling hoist match the sling clips.

The use of incompatible (i.e. non-BEKA Hospitec) slings can cause accidents!

Check that the sling is not twisted when attaching the sling. Always check that the sling clips are correctly attached prior to and during the lifting procedure and that they are tensioned while supporting the patient's weight. Check that the sling is not too tight and that the patient's arms are inside the sling.

### 8.2.1 Safe Attachment of the Clips in the Support



**Always check that the fastening clips are secured and correctly positioned prior to lifting the patient/resident!**

### 8.2.2 Safe Suspension of the Sling in the Support

**4-point Classic spreader bar:**

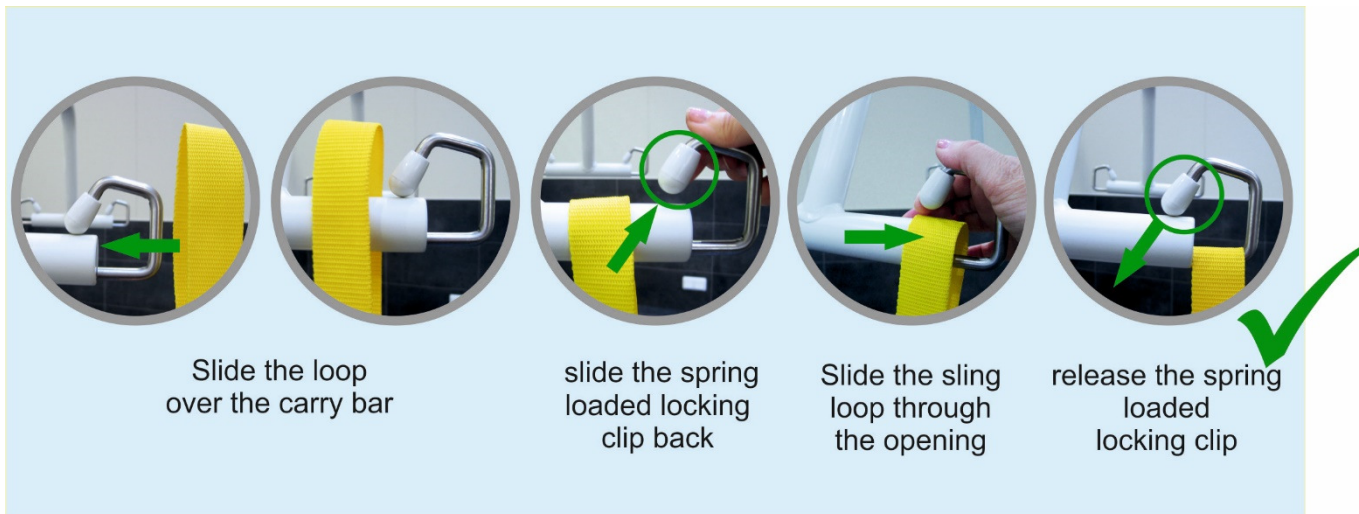

**Check that the loops are secured and correctly positioned prior to lifting the patient/resident!**

## 6-point Classic spreader bar:

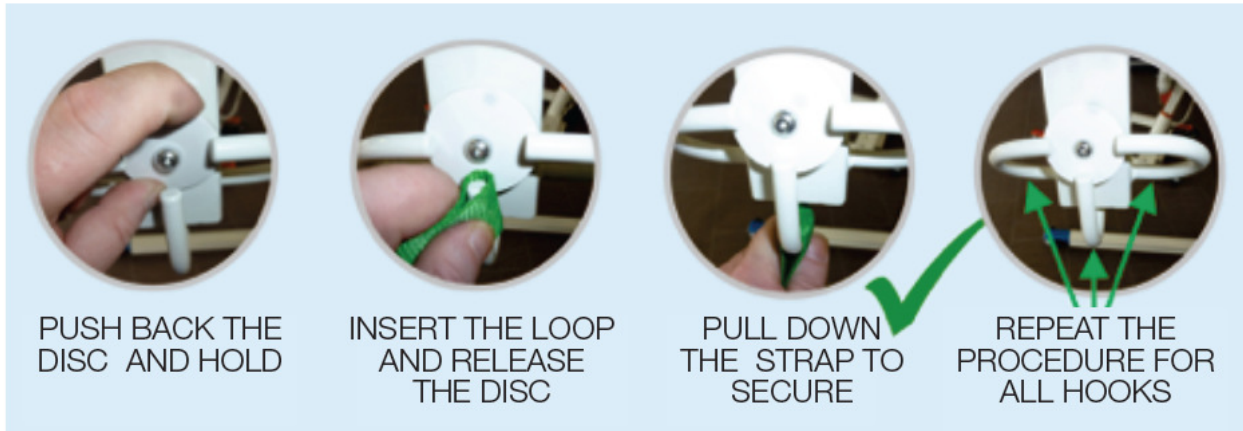

**Check that the loops are secured and correctly positioned prior to lifting the patient/resident!**

### 8.3 After Use

For the washing, the slings are classified as accessory and therefore as medical device. The slings may be cleaned and disinfected in accordance with the manufacturer's instructions.

During the washing and drying, no mechanical pressure must be applied, such as dry press, rotary iron. This could damage the sling parts and impair the operation and the safety of the sling or even destroy the sling.

The sling loops must be checked and, if required, cleaned after each use. The washing temperatures must not exceed the temperature specified on the sling. Please use common household detergents only. Do not iron hot. The plastic clips must be checked for possible damages after each wash.

## 9. Applying the BEKA Hospitec Sling in Sitting Position

### **Caution:**

Lead the sling with your hand downwards to the sitting surface so that the bottom of the sling is aligned with the coccyx (butt bone).

Make sure that the patient's head is located inside the cloth.

It is easier to apply the sling, when the patient leans slightly forward.

Pull the leg loops forward so that they are on the outside of the thigh. Make sure that the leg loops protrude equally.

**Pull on the left and the right side of the leg loops to straighten possible folds or wrinkles.**

Pull the leg loops one by one under the patient's thigh. Check that the sling is completely wrapped around the thigh without wrinkles or folds.

### **Caution:**

Now, you can attach the leg loops to the CARLO ALU either crosswise or parallel (only for loop slings), always one to the right and the other to the left of the hanger bar. Attach in any cases the 2 shoulder fixations as well as the 2 fixations for the legs to the CARLO ALU.

### **For 4-point Suspensions with Safety Clips for the 4-point Suspension:**

Never suspend the leg loop crosswise!

Always suspend individually with the safety clips to the 4-point spreader bar.

## 9.1 Applying the BEKA Sling in Lying Position

1. Turn the patient so that he/she is facing you. Fold the sling lengthways together and position the sling sideways as close as possible to the patient/resident. Make sure that the extremity of the sling is located at the height of the coccyx. Turn the resident/patient to the other side and pull the sling completely apart. Lift the headboard of the bed slightly up.
2. Insert the leg loop under the thigh. This is facilitated, when the patient's knee is bent. Check once more that the leg loops are completely wrapped around the thigh.
3. Make sure that the patient's head is located inside the cloth.
4. Fix the lifting loops in the shoulder area and then fix the leg loops. Slings with safety clips must be clipped into the fixing points of the sling hoist provided to this effect. Lift the patient/resident.

### **NOTE:**



**To avoid injuries, the arms and the head of the patient/resident must be *inside* of the sling.**



## 9.2 Manual for the Toilet Sling

**Caution:**

**The non-observance of the following instructions could cause injuries to other persons or to yourself.**

Always check that the patient/resident has sufficient self-control over his/her head and body to be lifted safely with a toilet sling. In case of doubt: use another suitable sling.

in order to have optimal access to the patient during the visit to the toilet, the toilet sling is equipped with an extremely large butt opening; as a consequence, you should pay particular attention that:

- a. The appropriate sling size for the body weight and body size of the patient/resident is chosen, and
- b. Both arms of the patient/resident are located outside of the sling, above the upholstered arm-pit area, but underneath the fixations of the loops for the head support area.

In case of a correct operation, this prevents the patient/resident from slipping through the butt opening.

Apply the toilet sling to the patient/resident so that the head support area of the sling is at the same height as the patient's/resident's head. The bottom part of the sling is fixed at approx. the height of the patient's hips, depending on his/her body size.

Always make sure that the sling clips (for loop slings, the loops) are safely and securely fixed to all points of the spreader bar provided to this effect, prior to lifting the patient/resident. Slowly raise the CARLO ALU in order to be able detecting and correcting immediately possible incorrect fixations.

**Note:**

We recommend opening the buckles of the head area prior to applying the sling and to close them again after the sling has been applied. Make sure that the patient's/resident's arms are located outside of the sling and over the upholstered arm-pit area.

Always make sure that the patient/resident is in an upright sitting position when he/she is being lifted and transferred with the CARLO ALU.

If you respect and observe these instructions, the toilet sling will be an efficient aid for the toilet visit.

## 10. Operation of the CARLO ALU

The spreader bar of the CARLO ALU sling hoist is raised or lowered by means of the handset, which is included in the delivery. The direction of motion is indicated by symbols. The rear castors have (ease-to-operate) brakes. When lifting a patient/resident, the brakes of the castors must be activated to avoid any uncontrolled movement of the CARLO ALU.

### Travel path

When using the CARLO ALU, make sure that the travel path of the CARLO ALU is not narrowed by obstacles or other elements (e.g. wall racks, etc.). Remember also that the maximum height is limited to 2175 mm. Take extreme care when passing through door frames.

### 10.1 Explanation of the Functions of the Handset

The different functions of the CARLO ALU can be activated by means of the handset.

#### **Raising and Lowering the Spreader Bar**

Keep the button  of the handset pressed to raise the spreader bar. The spreader bar is raised. Release the button as soon as the spreader bar has reached the desired position. The upward movement of the spreader bar is stopped.

When the highest possible position is reached, the upward movement is automatically stopped.

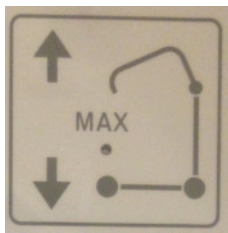

Keep the button  of the handset pressed to lower the spreader bar. The spreader bar is lowered. Release the button as soon as the spreader bar has reached the desired position. The downward movement of the spreader bar is stopped.

When the lowest possible position is reached, the downward movement is automatically stopped.

If the LED-indication "MAX" is displayed  the highest possible load capacity of the CARLO ALU is reached. In such case, lower the patient and use another sling hoist with a higher load capacity.

#### **Spreading of the Carrier Frame**

Keep the button  of the handset pressed to spread the carrier frame. The carrier frame of the CARLO ALU is spread. Release the button as soon as the desired spread width is reached. The spreading movement is stopped. When the maximum spreading position is reached, the movement is automatically stopped.

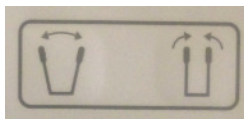



Keep the button  of the handset pressed to close the carrier frame. The carrier frame of the CARLO ALU is closed. Release the button as soon as the desired spread width is reached. The spreading movement is stopped. When the minimum spreading position is reached, the movement is automatically stopped.

The spreadable carrier frame highly increases the stability of the sling hoist.

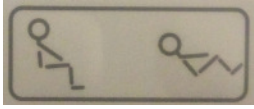
***Tilting the  
Spreader Bar  
(only possible  
with EP  
spreader bar)***



Keep the button  of the handset pressed to change the sitting position of the patient/resident. The spreader bar is tilted backwards, thus bringing the patient/resident into a lying position. Release the button as soon as the desired position is reached. The tilting movement is stopped. When the end position is reached, the tilting movement is automatically stopped.

Keep the button  of the handset pressed to set the spreader bar back upright. The spreader bar is tilted forwards, thus bringing the patient/resident into a sitting position. Release the button as soon as the desired position is reached. The tilting movement is stopped. When the end position is reached, the tilting movement is automatically stopped.

## 10.2 Lifting a patient/resident

Proceed in the following way to lift a patient/resident from a chair:

1. Apply the sling in accordance with the operating manual (par. 9).
2. Position the CARLO ALU (without suspended sling) with the carrier frame spread aside the patient/resident.
3. Slide the sling downwards at the back of the sitting patient/resident. Pull the leg loops forward and lift one leg at the time. Bring the leg loops under the patient's/resident's leg. Check that the shoulders and the head of the patient/resident are correctly positioned in the sling. Particularly make sure that the patient's head is located inside the sling.
4. Use the lifting arm to bring the spreader bar in a position, which enables you to attach the loops or clips to the attachment points. If your CARLO ALU is equipped with an EP spreader bar, you possibly must change the position of the hanger bar to be able reaching the attachment points.
5. Suspend the sling to the lifting eye. Check that the sling is correctly fixed. The sling hoist has 4 or 6 fixing points (depending on the spreader bar type) to enable an individual adjustment to each patient/resident.
6. Activate the brakes of the rear castors.
7. You can now raise the patient/resident.
8. If your CARLO ALU is equipped with an EP spreader bar, you can change the position of the spreader bar if needed to bring the patient from a lying into a sitting position.
9. Close the carrier frame. The lowering of the CARLO ALU is enhanced when the carrier frame is not spread.
10. Release the brakes of the rear castors.
11. You can now transfer the patient to the desired location with the CARLO ALU. To move the sling hoist, push or pull the handles provided to this effect. Do not push or pull the sling hoist or the cylinder bar of the motor.

### 10.3 Putting the patient/resident down

When you have reached the desired location, you can put the patient/resident e.g. on a chair or in bed. Proceed in the following manner:

1. Spread the carrier frame if needed up to the maximum possible spread width.
2. Bring the CARLO ALU with the patient/resident over the intended location.
3. If your CARLO ALU is equipped with an EP spreader bar, you can change the position of the spreader bar if needed to bring the patient from a lying into a sitting position.
4. Check that the chair or the bed stands safely; activate the brakes of the wheelchair if required.
5. Lower the lifting arm with the spreader bar until the patient/resident sits safely in the chairs or lies safely on the bed and the loops of the sling are relieved.
6. Remove the loops or the clips of the sling from the spreader bar.
7. Pull the CARLO ALU away from the patient. Make sure to pull the CARLO ALU straight backwards to avoid injuring the patient with the spreader bar. If required, raise the spreader bar to avoid injury of the patient/resident.
8. Put the CARLO ALU at a safe location.
9. Remove the sling from the patient/resident.

**Caution:**

**The CARLO ALU is exclusively fit for indoor use.**

**Caution:**

**Do not move the CARLO ALU over sloping or uneven floors.**

**Warning:**

**Make sure that the CARLO ALU is not tilted over 5° when driving over thresholds or similar. The CARLO ALU could fall over in this case!**

## 11. Digital scale SLS (option)

### 11.1 Safety Instructions Digital Scale SLS

- The SLS digital scale meets the requirements of 90/384/EEC and 73/23/EEC and is interference-suppressed according to the applicable EC-Directive 89/336/EEC.
- The construction neither the safety technology of the device may be changed. Each alteration shall exclude the liability from BEKA Hospitec for the resulting damages.
- Any repairs, soldering operations to the circuit board and the exchange of parts is prohibited. Repairs may only be carried out by persons authorized by BEKA Hospitec.
- Waste equipment that is no longer functional or suitable for use must be disposed of separately from normal household wastes in accordance with the national and local regulations on environmental protection and raw material recycling.

### 11.2 Cleaning of the Scale

- Wipe the scale clean with a damp cloth. Use a normal cleaner in the event of heavier soiling. Never use abrasive or corrosive cleaners.

### 11.3 Instructions

In order to ensure a proper operation of the scale, please observe the following:

- **Prior to Weighing**

Push the on/off button to switch the scale on. Wait until the scale is automatically tarred to 0.0 kg. Now, you can suspend the sling with the patient/resident.

- **Preparing the Weighing Procedure**

Bring the hanger bar into the weighing position so that the patient's/resident's legs are oriented towards the lifting column. The scale is now in horizontal position and you can read the correct weight.

#### **Caution**

If the patient's/resident's legs are not oriented towards the lifting column, it is possible that the correct weight is not displayed.

- **Operating the Scale**

Make sure that the patient/resident is hanging free and that the weighing procedure is not influenced by the patient/resident partly resting on e.g. a chair, a wheelchair, a bed. Now, you can read the patient's/resident's weight on the display.

#### **Caution**

When calculating the weight, please observe that the proper weight of the sling and the clothes of the patient/resident must be deduced from the displayed weight to determine the actual body weight.

## 11.4 Putting the Scale into Operation

Unscrew the right cover plate.

Insert the battery enclosure with batteries (4 x 1.5 V - AA-type) under consideration of the specified polarity.

Screw the cover plate back on.

The scale is now ready to use.

### ○ Weighing

#### Switching the Scale on without Patient/Resident:

The scale is operational approx. 10 seconds after it has been switched on.

**During this time, the scale must be moved or loaded!**

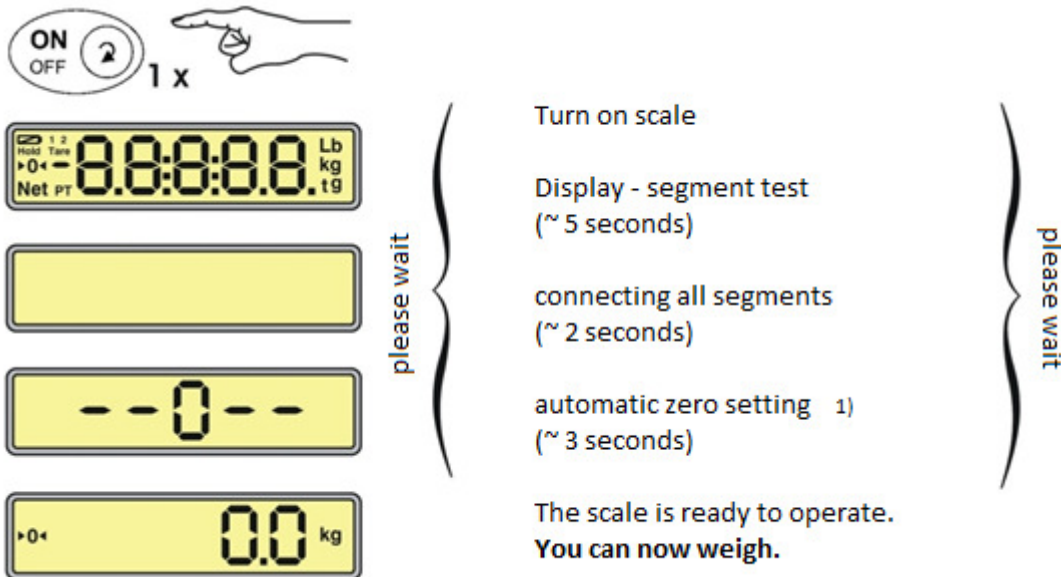

If the preload of the scale (tare) exceeds 20% of the weighing range, the auto-zeroing is not executed. In this case, manual tarring is required.

### 11.5 Tarring/Adding

Switch the scale on and wait ~ 10 seconds.

Suspend the weight to be tarred (e.g. sling).

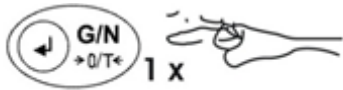

Tare



Now you can weigh. <sup>2)</sup>

<sup>2)</sup> By repressing the G/N button you can witch between weight-null and gross-weight.

Continuing hooked to tared weight

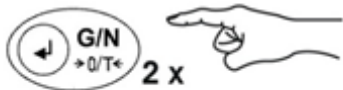

Tare <sup>3)</sup>



Now you can weigh.

<sup>3)</sup> After the first press, the G/N button will display the current total (gross) weight. By repressing, the G/N button is tared. You can repeat this process as often as you wish to acheive the maximum weight range of the scale.

- **Switching the Scale on with Patient/Resident:**

Before turning on the scale, hook strap-on device with patient.



Turn on scale



Display-Segment test  
(~ 5 seconds)

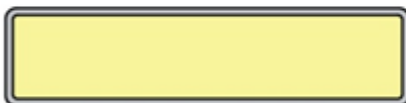

connecting all segments  
(~ 2 seconds)



Complete weight is displayed.  
(with strap-on device!)

please wait

please wait

**Caution:**

If a zero is displayed here, weighing is impossible.





Press the button **ON/OFF**:  
Tare



Complete weight will be set to null



After removal of the patient from the strap-on device, the weight will be displayed with a negative sign. (Strap-on device must remain hooked!)

○ **Switching off**



Pressing the button **ON/OFF** turns the scale off.

○ **Error messages**

**Overload**



Scale overloaded!  
Please pay attention to the scale's load rating  
(see identification plate on rear of device)

**Underload**



Turn scale off and reset.

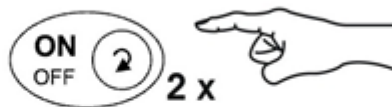

**Battery status**

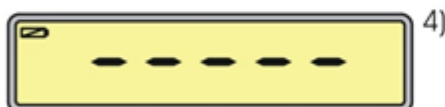

The batteries are empty and have to be changed!

<sup>4)</sup> For non-custody transfer weights, you can be wigher still one time after appearance of the battery symbol. To eliminate measurement errors, the batteries should however be immediately changed.

Replace the batteries as described in par. 11.4, Putting the Scale into Operation.

## 11.6 Unit Conversion (kg < - > Lb.)

>>> **Only enabled for non-legal-for-trade scales!** <<<

Switch the scale on and wait ~ 10 seconds



Unit **kg**



**hold pressed ~ 5 seconds**



Unit **Lb** (American pound)

The changeover from **Lb.** to **kg** takes place in the same way.  
The last set unit is saved, even after the device is switched off.

### ○ **Setting/Changing the Switch-Off Time**

Switch the scale on and wait ~ 10 seconds.

**Simultaneously** press on the **ON/OFF** and **G/N** button to activate the dialogue mode.

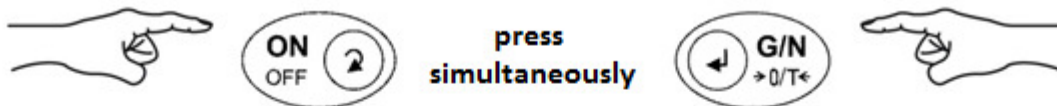

**press  
simultaneously**



Dialog mode ( *Standard\_F unction* )



Turn off time ( *Power Off* )



Select by **multiple** presses  
of **ON/OFF** button (digit blinks):



Only turn off **manually**  
(with **ON/OFF** button)

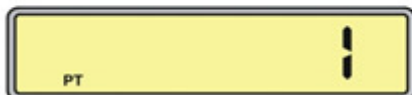

Turns off **automatically after 30 sec.**  
(only with unloaded scale)



Turns off **automatically after 60 sec.**  
(only with unloaded scale)



Turns off **automatically after 5 min.**  
(only with unloaded scale)



Turns off **automatically after 10 min.**  
(only with unloaded scale)



Confirm the selection with **G/N** button



*At this point, you can control, or change again, PO by repressing the **ON/OFF**.*

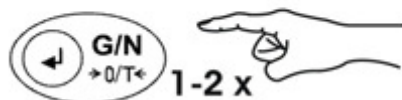

press **1 x**:  
filter settings **AF**  
(see next page)

or press **2 x**:  
return to scale mode



or



## 11.7 Filter Setting/Modification (Stabilization of the Weight Display)

Switch the scale on and wait ~ 10 seconds .

**Simultaneously** press on the **ON/OFF** and **G/N** button to activate the dialogue mode.

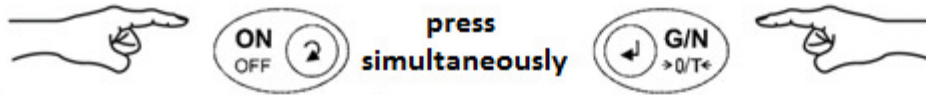

Dialog mode ( *Standard\_F*unction)



Filter setting (amplifier filter)



Select by **multiple** presses of **ON/OFF** button (digit blinks):



0 = filtering turned off



1 = light filtering  
+ very fast weight display  
- bumpy display during movement



4 = middle filtering:  
+ **fast weight display**  
+ **steady display**



8 = very strong filtering:  
+ weighing of unsteady person possible  
- long wait time until weight or null point of the scale will be displayed stable  
Certification of selection and acceptance of transfer with **G/N** button



*At this point, you can control, or change again, PO by repressing the **ON/OFF**.*

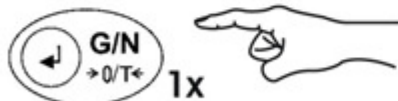

back to weighing mode

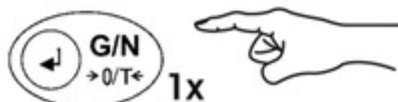

**You can now weigh.**

## 12. Maintenance and Care of the 24-Volt Battery

The battery and the control box must not be opened by the customer.

Repairs may be carried out only either by BEKA Hospitec or by companies authorized to this effect by BEKA Hospitec. If the battery is discharged, recharge it as soon as possible to extend the lifetime. Batteries stored in the warehouse/stock must be recharged every 6 months (a possible deep discharge may destroy the battery). The battery's lifetime basically depends on the charge (number of lifting cycles) and the charging state. It can be up to 5 years. Have defective or worn out batteries, and defective charging units in general, replaced.

### 12.1 Contact Persons for Technical Information

For technical information and in case of questions regarding the use, please contact the medical devices consultant of your dealer or the manufacturer:



BEKA Hospitec GmbH  
Am Rübenmorgen 3 • 35582 Wetzlar  
Phone: +49(0)641-9 22 20 - 0  
Fax: +49(0)641-9 22 20 - 20  
info@beka-hospitec.de  
www.beka-hospitec.de

## 13. Cleaning/Disinfection

### 13.1 Cleaning of the CARLO ALU Sling Hoist

Clean the CARLO ALU with a soft, lint-free cloth. For thorough cleaning, use a cloth moistened with a mild soap solution. You can use a cloth moistened with an isopropyl alcohol solution for the disinfection.

To avoid damages to the CARLO ALU, **no** abrasive cleaners or solvents must be used to clean the control unit.

**Caution:**



**Make sure  
that during the cleaning  
the system is not operational!**

**WARNING:**

After each treatment, the **CARLO ALU** must be completely disinfected with a disinfectant to avoid cross-contamination.

**Caution:**

Use disinfectants only when the **CARLO ALU** is not in use. Strictly respect and observe the manufacturer's instructions for the used disinfectant. Avoid direct contact with the concentrated product. If necessary, use gloves and safety glasses to protect your skin and eyes.

The **CARLO ALU** can be cleaned with a damp cloth and a normal cleaning agent for plastics. For the disinfection of the surface, an isopropyl alcohol solution or a customary disinfection aerosol (spray) can be used.

### 13.2 Disinfecting the **CARLO ALU**

You must carefully disinfect your **CARLO ALU** after each use to avoid risk of infection. For the disinfection, an isopropyl alcohol solution or a customary disinfection aerosol (spray) can be used.

**Caution:**

Disinfect the **CARLO ALU** only when the patient/resident has left the sling hoist. Strictly respect and observe the manufacturer's instructions for the used disinfectant. Avoid direct contact with the concentrated product. If necessary, use gloves and safety glasses to protect your skin and eyes.

### 13.3 Sterilization

The **CARLO ALU** is **not** suitable for sterilization.

## 14. Waste Disposal

### 14.1 Disposal of the Packaging Material

Please recycle the packaging materials of the **CARLO ALU** in accordance with the locally applicable regulations and laws.

### 14.2 Disposal of the Product

At the end of the product's lifetime, contact your **BEKA** dealer, who will recycle the **CARLO ALU** in accordance with the locally applicable regulations and laws.

For an environmentally-sound disposal, the company **BEKA Hospitec GmbH** will provide more information in its capacity of manufacturer.

Please clean and disinfect the **CARLO ALU** prior to its disposal as well.

## 15. Prescribed Inspections & Checks

In order to ensure a safe use of the CARLO ALU and the protection of the users and the patients/residents, BEKA Hospitec prescribes an annual safety check.

We recommend a simultaneous maintenance of the device in order to conserve its full value.

The execution of the safety checks and maintenance must be documented and proven on request. Please use your inventory register to this effect.

The checks may only be conducted by the manufacturer either by specialists authorized by the manufacturer.

	<p><b>Caution:</b> In accordance with the UVV (accident prevention) regulations of the German employer's liability insurance association on mobile equipment which is used in special locations or installations, an annual check to the DGUV (German Statutory Accident Insurance Association) Prescription 3 (BGV A3) must be carried out on the CARLO ALU.</p>
---	---

This check is only prescribed for Germany.

In other countries, other requirements might be applicable.

**Daily/prior to each use:** Cleaning, disinfecting.

**Weekly checks:** Visual checks of all components, power cables and electrical connections, functional test, clean castors if necessary.

**Annual checks:** Safety check, maintenance, DGUV Prescription 3.

	<p><b>Caution:</b> Do not conduct any cleaning, maintenance or test activities when the CARLO ALU is in use. This could cause danger to the user and the patient/resident.</p>
---	--



## 15.1 Prior to each use

To ensure a safe and failure-free operation, the following checks must be carried out prior to each use:

- Visual check of the CARLO ALU (external damages and wear-and-tear).
- Check that no screws of the CARLO ALU are missing or loose.
- Check the proper functioning of the CARLO ALU.
- Check the proper functioning of the spreader bar.
- Check the proper functioning of the handset (up/down, spreading, spreader bar inclination)
- Check the emergency lowering system.
- Check the smooth running of the castors.
- Check the slings for damages.
- Check the state of charge of the battery

In case of questions regarding the checks and to find a competent partner to conduct the checks, please contact your BEKA Hospitec dealer or BEKA Hospitec GmbH.



BEKA Hospitec GmbH  
Am Rübenmorgen 3 • 35582 Wetzlar  
Phone: +49(0)641-9 22 20 - 0  
Fax: +49(0)641-9 22 20 - 20  
info@beka-hospitec.de  
www.beka-hospitec.de

## 16. Troubleshooting and After-sales Service

### 16.1 Help for Troubleshooting

Problems with the Sling Hoist	Remedy
The travel adjustment and the spreading of the carrier frame of the CARLO ALU do not function.	<ul style="list-style-type: none"> <li>a) Check if the emergency stop switch is released/pressed.</li> <li>b) Check that the cables of the control box are correctly connected.</li> <li>c) Check the battery's state of charge.</li> <li>d) Remove the battery pack and check the contacts for damage.</li> </ul>
The CARLO ALU remains in the top end position.	<ul style="list-style-type: none"> <li>a) Check if the emergency stop switch is released/pressed.</li> <li>b) Check the battery's state of charge.</li> <li>c) Use the electrical emergency lowering feature (see 8.4) to lower the patient/resident.</li> <li>d) Use the mechanical emergency lowering feature (see 8.3) to lower the patient/resident.</li> </ul>
The carrier frame motor does not run.	<ul style="list-style-type: none"> <li>a) Check if the emergency stop switch is released or pressed.</li> <li>b) Check that the control box is correctly plugged in.</li> <li>c) Check the battery.</li> </ul>
The drive stops during the lifting procedure.	<ul style="list-style-type: none"> <li>a) Battery low. <b>Charge the battery.</b></li> <li>b) The maximum load is exceeded (max. patient weight).</li> </ul>
The electrical positioning system does not respond.	<ul style="list-style-type: none"> <li>a) Make sure that the handset is connected.</li> <li>b) Check the plug-in connector at the control box.</li> <li>c) Check the battery.</li> </ul>
The control box emits a "beep" signal when operated.	<p style="text-align: center;">Battery low. <b>Charge the battery.</b></p>
The handset does not work.	<ul style="list-style-type: none"> <li>a) Check the connectors at the handset cable and the motors.</li> <li>b) Check the battery's charging state (replace with fully charged battery).</li> </ul>
The up and down buttons of the handset do not respond.	<ul style="list-style-type: none"> <li>a) Check if the emergency stop switch is released or pressed.</li> <li>b) Check the battery's charging state (replace with fully charged battery).</li> <li>c) Check that the cables of the control box are correctly connected.</li> </ul>
The castors produce loud noises.	<p style="text-align: center;">Clean castors if necessary. Replace if necessary.</p>

The CARLO ALU produces unusual noises.	Inform the after-sales service.
The CARLO ALU is damaged.	Inform the after-sales service.
The “Service” indication is lit.	The annual check must be carried out.
<b>Problems with the Charging Unit</b>	<b>Remedy</b>
The charging unit does not work.	a) Remove the battery pack and check the contacts for damage. b) Check the mains plug.
The operating display of the charging unit is not lit.	a) Check that the charging unit is connected to a power outlet. b) Check the power outlet fuse.
The charging unit is connected to the power outlet, but the operating display is not lit.	a) Check that the wall outlet is supplied with power. b) Remove the battery and check for damage.
<b>Problems with the Battery</b>	<b>Remedy</b>
The battery is placed correctly, but the indicator lights are not lit.	Inform the after-sales service.
The indicator light does not go out after multiple hours of charging.	The battery must be replaced. Inform the after-sales service.
The battery installed in the charging unit indicates that it is fully charged. However, when placed in the CARLO ALU, just a few lifting cycles are possible.	The battery must be replaced. Inform the after-sales service.
When the handset is actuated, an acoustic signal is emitted and the indicator light (red) is on.	Check the battery’s charging state.

## 16.2 After-sales Service

When your CARLO ALU does not function properly and you cannot eliminate the error by means of the remedies listed in paragraph 16, please contact the customer service of your dealer either the manufacturer.



BEKA Hospitec GmbH  
 Am Rübenmorgen 3 • 35582 Wetzlar  
 Phone: +49(0)641-9 22 20 - 0  
 Fax: +49(0)641-9 22 20 - 20  
 info@beka-hospitec.de  
 www.beka-hospitec.de

## 17. Appendix

### 17.1 Technical Data

#### Dimensions and weights

- Length:	129.0 cm
- Width in closed condition:	70.0 cm
- Width in open condition:	118.0 cm
- Min. height:	134.0 cm
-Max. height:	217.0 cm
- Travel with hanger bar:	20.0 - 158.0 cm
- Travel without hanger bar:	68.5 - 208.5 cm
- Weight without packaging:	Approx. 55 kg depending on the variant
- Safe Working Load (SWL):	<b>max. 185 kg</b>

#### Electrical data

##### Control unit/Charging unit

- Protection class:	Class II
- Applied part:	Type B
- Operating mode:	Short-term operation
- Input voltage:	100 V - 240 V~ (AC) / 50 / 60 Hz
- Output voltage:	24 V (DC)
- Power consumption	I in max. 1 Amp
- Duration of treatment:	6 double lifts, 25 min. pause

##### Hoist motor:

- Operating mode:	Short-term operation
- Input voltage:	24 V (DC)
- Power consumption	I in max. 10 Amp
- Protection class:	IP X4
- Duration of treatment:	2 min. continuous operation followed by 18 min. pause

##### Spreading motor

- Operating mode:	Short-term operation
- Input voltage:	24 V (DC)
- Power consumption	I in max. 5 Amp
- Protection class:	IP X4
- Duration of treatment:	max. 10%, continuous operation 6 min./h

**Ambient conditions****Operation**

- Temperature range: 10° C to 40° C
- Relative humidity: 30% to 75%, non-condensing
- Atmospheric pressure: 800 – 1060 hPA

**Storage and transport**

- Temperature range (stand-up and raising aid): -40° C to 70° C
- Temperature range (battery): -15° C to 40° C
- Relative humidity: 10% to 80%, non-condensing
- Atmospheric pressure: 500 – 1100 hPA

**17.2 Manufacturer**

BEKA Hospitec GmbH  
Am Rübenmorgen 3 • 35582 Wetzlar  
Phone: +49(0)641-9 22 20 - 0  
Fax: +49(0)641-9 22 20 - 20  
info@beka-hospitec.de  
www.beka-hospitec.de



### 17.3 Dimensions CARLO ALU, Classic / EP

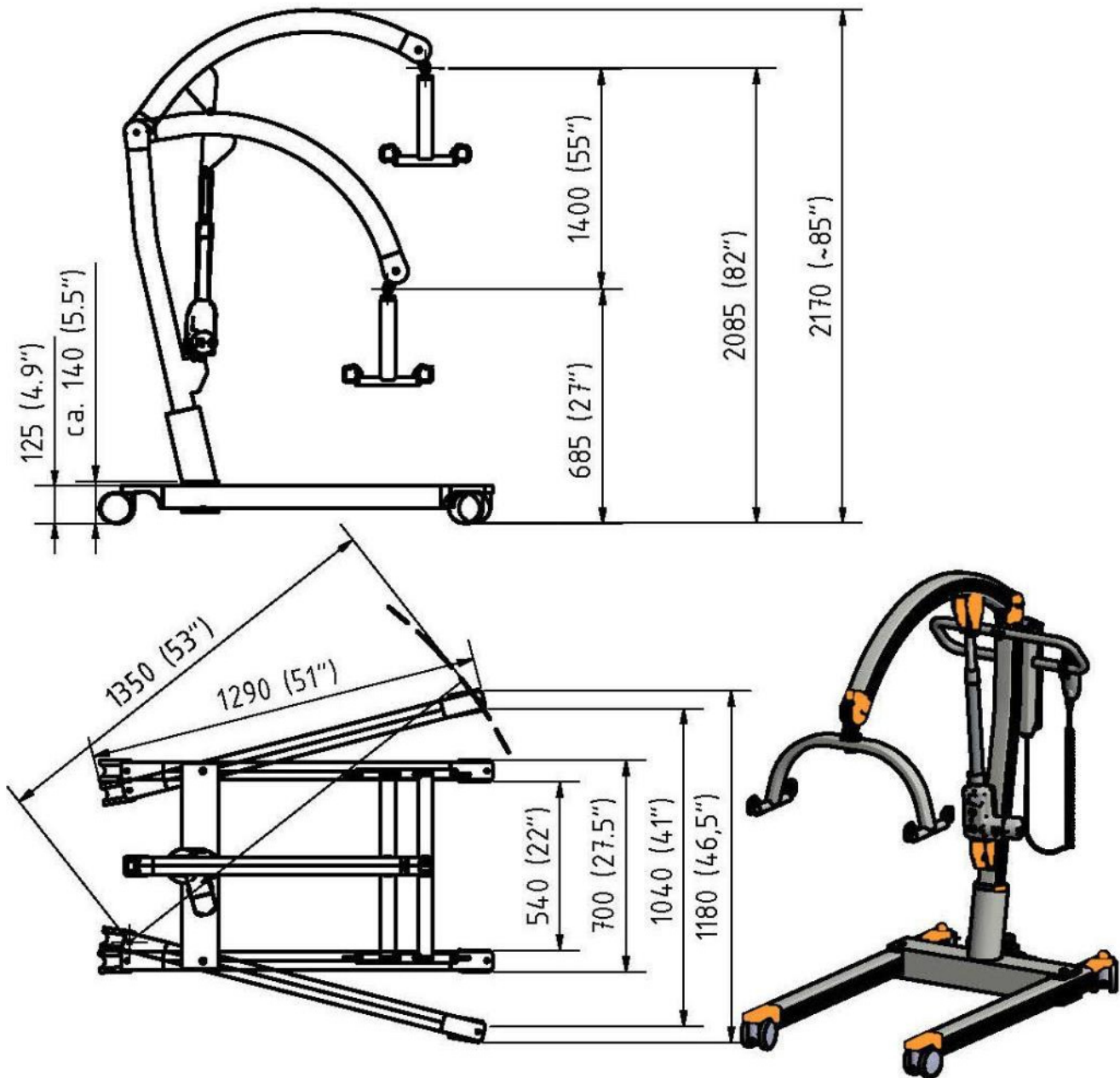

Note: Depending on the hanger bar used and the use of the optionally available scale, the distance from the floor to the sling suspension is different!

## 17.4 Declaration of Conformity



### EG-Konformitätserklärung / EC-Declaration of Conformity

Der Hersteller / *The manufacturer*

**BEKA Hospitec GmbH  
Am Rübenmorgen 3  
D-35582 Wetzlar-Dutenhofen**

erklärt in alleiniger Verantwortung gemäß EG-Richtlinie für Medizinprodukte 93/42/EWG Annex VII,  
dass die folgenden Produkte  
*declares under sole responsibility according to the EU Medical Device Directive 93/42/EEC, Annex VII that  
the following products*

CARLO Alu (Classic 185)	Artikel Nr. P/N.	924003100, 924003200, 924002008, 924002018, 924003208, 924003218
CARLO Alu (Classic 230)	Artikel Nr. P/N.	924001500, 924001508, 924001518, 924003008, 924003018
CARLO Alu (Comfort GPL)	Artikel Nr. P/N.	925001000, 925001008, 925001018
CARLO Alu (Comfort EP 185)	Artikel Nr. P/N.	925006000, 925006008, 925006018
CARLO Alu (Comfort EP 230)	Artikel Nr. P/N.	925007000, 925007008, 925007018

den grundlegenden Anforderungen entsprechen und die Voraussetzungen für die CE-Kennzeichnung erfüllen.  
*comply with the essential requirements and fulfill the provisions of CE marking.*

Die Bauart der Produkte entspricht Klasse I des Medizinproduktegesetzes (MPG), Regel 12.  
*The products correspond with Class I Medical Device Directive (MDD), Rule 12.*

Zur Beurteilung wurden folgende Normen / Richtlinien herangezogen:  
*The following standards / directives apply:*

<b>EG-Richtlinie 93/42/EWG/ Directive 93/42/EEC</b>		<b>DIN EN ISO 14971:2013</b>
<b>DIN EN 10535:2007</b>		<b>DIN EN 60601-1:2007</b>
<b>DIN EN 12182:2012</b>		<b>DIN EN 60601-1-2:2007</b>

Diese Erklärung trifft auf alle Produkte zu, die nach Ausstellung dieser Erklärung produziert wurden, bis sie  
durch eine andere Erklärung ersetzt wird.  
*This declaration applies to all CE marked devices manufactured from the date of its issuance on until it is  
either superseded by another declaration or withdrawn.*

**Technische Änderungen vorbehalten / Technical changes reserved.**

Wetzlar, den 07.03.2016

Robert Deschler  
Geschäftsführer

Thomas Neumann  
Geschäftsführer

BEKA Hospitec GmbH  
Am Rübenmorgen 3  
D-35582 Wetzlar-Dutenhofen  
Fon 0641 / 92 22 0-0  
Fax 0641 / 92 22 0-20

USt.-IdNr.: DE278603356  
Amtsgericht Wetzlar, HRB 6207  
info@beka-hospitec.de  
www.beka-hospitec.de

Geschäftsführung  
James Stuart-Smith  
Robert Deschler  
Thomas Neumann

Commerzbank AG Wetzlar  
Konto-Nr.: 482176500  
BLZ: 615 400 37  
IBAN: DE60515400370482176500  
SWIFT-BIC: COBADEFF515





## 17.5 Accessories of the Sling Hoists CARLO Alu Classic 185Kg

<b>Basic device</b>			
Description	Article number	Description	Article number
CARLO Alu, Classic 185 Incl. 4-point spreader bar (Only for slings with loops)	924003100	CARLO Alu Classic 185 Incl. 6-point spreader bar (only for slings with loops)	924003200
	924002008		924003208
	924002018		924003218
<b>General accessories</b>			
Spare battery 24V	921070602	Wall charger	921070702

<b>Slings with loops Europe</b>		
Description	Size	Article number
Nylon transfer sling	Size "S"	923003100
Nylon transfer sling	Size "M"	923003200
Nylon transfer sling	Size "L"	923003300
Nylon transfer sling	Size "XL"	923003400
Nylon transfer sling	Size "XXL"	923003500
Bathing sling	Size "S"	923004100
Bathing sling	Size "M"	923004200
Bathing sling	Size "L"	923004300
Bathing sling	Size "XL"	923004400
Bathing sling	Size "XXL"	923004500
Nylon toilet sling	Size "M"	923005200
Nylon toilet sling	Size "L"	923005300
Nylon toilet sling	Size "XL"	923005400

<b>Slings with loops US/ Canadian version:</b>		
Description	Size	Art. N°
Nylon transfer sling	Size S	923003103
Nylon transfer sling	Size M	923003203
Nylon transfer sling	Size L	923003303
Nylon transfer sling	Size XL	923003403
Nylon transfer sling	Size XXL	923003503
Bathing sling	Size S	923004103
Bathing sling	Size M	923004203
Bathing sling	Size L	923004303
Bathing sling	Size XL	923004403
Bathing sling	Size XXL	923004503
Nylon toilet sling	Size S	923005103
Nylon toilet sling	Size M	923005203
Nylon toilet sling	Size L	923005303
Nylon toilet sling	Size XL	923005403
Nylon toilet sling	Size XXL	923005503



<p>Transfer sling with loops Transfer sling with loops</p>	<p>Description Description</p>	<p>Guidelines for sling sizes Guideline for sling sizes</p>		
	<p>made of nylon washable at max. 60°C</p>	<p>Size S M L XL XXL</p>	<p>Weight 35-65 kg 55-85 kg 75-125 kg 120-160 kg 160-210 kg</p>	<p>Color red yellow green blue orange</p>
<p>Bathing sling with loops Bathing sling with loops</p>	<p>Description Description</p>	<p>Guidelines for sling sizes Guideline for sling sizes</p>		
	<p>made of nylon washable at max. 60°C</p>	<p>Size S M L XL XXL</p>	<p>Weight 35-65 kg 55-85 kg 75-125 kg 120-160 kg 160-210 kg</p>	<p>Color red yellow green blue orange</p>
<p>Toilet sling with loops Toilet sling with loops</p>	<p>Description Description</p>	<p>Guidelines for sling sizes Guideline for sling sizes</p>		
	<p>made of nylon washable at max. 60°C</p>	<p>Size S M L XL XXL</p>	<p>Weight 35-65 kg 55-85 kg 75-125 kg 120-160 kg 160-210 kg</p>	<p>Color red yellow green blue orange</p>

## 17.6 Accessories CARLO Alu Comfort EP 185

<b>Basic device</b>			
Description	Article number		
CARLO Alu Comfort EP 185 Incl. 4-point spreader bar (Only for clip slings)	925006000 925006008 925006018		
<b>General accessories</b>			
Spare battery 24V	921070602	Wall charger	921070702

<b>Slings with clips Europe</b>		
Description	Size	Article number
Nylon transfer sling	Size "S"	922005100
Nylon transfer sling	Size "M"	922005200
Nylon transfer sling	Size "L"	922005300
Nylon transfer sling	Size "XL"	922005400
Nylon transfer sling	Size "XXL"	922005500
Bathing sling	Size "S"	922006100
Bathing sling	Size "M"	922006200
Bathing sling	Size "L"	922006300
Bathing sling	Size "XL"	922006400
Bathing sling	Size "XXL"	922006500
Nylon toilet sling	Size "M"	922007200
Nylon toilet sling	Size "L"	922007300
Nylon toilet sling	Size "XL"	922007400
Nylon sling for double leg amputees	Size "S"	922005117
Nylon sling for double leg amputees	Size "M"	922005217
Nylon sling for double leg amputees	Size "L"	922005317
Nylon sling for double leg amputees	Size "XL"	922005417
Nylon sling for double leg amputees	Size "XXL"	922005517

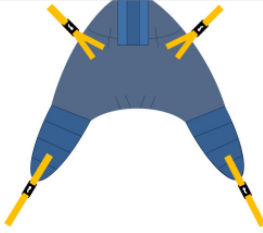
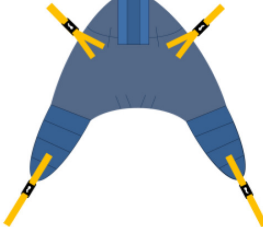
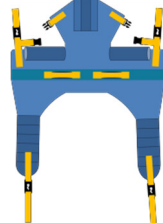
<b>Slings with clips US/ Canada</b>		
<b>Slings with clips</b>	<b>Description</b>	<b>Art. N°</b>
Nylon transfer sling	Size S	922005103
Nylon transfer sling	Size M	922005203
Nylon transfer sling	Size L	922005303
Nylon transfer sling	Size XL	922005403
Nylon transfer sling	Size XXL	922005503
<b>Slings with clips + 10 cm (extended leg loops)</b>	<b>Description</b>	<b>Art. N°</b>
Nylon transfer sling	Size S	922005113
Nylon transfer sling	Size M	922005213
Nylon transfer sling	Size L	922005313
Nylon transfer sling	Size XL	922005413
Nylon transfer sling	Size XXL	922005513
<b>Slings with clips</b>	<b>Description</b>	<b>Art. N°</b>
Bathing sling	Size S	922006103
Bathing sling	Size M	922006203
Bathing sling	Size L	922006303
Bathing sling	Size XL	922006403
Bathing sling	Size XXL	922006503
<b>Slings with clips + 10 cm (extended leg loops)</b>	<b>Description</b>	<b>Art. N°</b>
Bathing sling	Size S	922006113
Bathing sling	Size M	922006213
Bathing sling	Size L	922006313
Bathing sling	Size XL	922006413
Bathing sling	Size XXL	922006513
<b>Slings with clips</b>	<b>Description</b>	<b>Art. N°</b>
Nylon toilet sling	Size S	922007103
Nylon toilet sling	Size M	922007203
Nylon toilet sling	Size L	922007303
Nylon toilet sling	Size XL	922007403
<b>Slings with clips + 10 cm (extended leg loops)</b>	<b>Description</b>	<b>Art. N°</b>
Nylon toilet sling	Size S	922007113
Nylon toilet sling	Size M	922007213
Nylon toilet sling	Size L	922007313
Nylon toilet sling	Size XL	922007413
<b>Slings with clips</b>	<b>Description</b>	<b>Art. N°</b>
Nylon sling for double leg amputees	Size S	922005117
Nylon sling for double leg amputees	Size M	922005217
Nylon sling for double leg amputees	Size L	922005317
Nylon sling for double leg amputees	Size XL	922005417
Nylon sling for double leg amputees	Size XXL	922005517

<p>Transfer sling with clips Transfer sling with clips</p>	<p>Description Description</p>	<p>Guidelines for sling sizes Guideline for sling sizes</p>		
	<p>made of nylon washable at max. 60°C</p>	<p>Size S M L XL XXL</p>	<p>Weight 35-65 kg 55-85 kg 75-125 kg 120-160 kg 160-210 kg</p>	<p>Color red yellow green blue orange</p>
<p>Bathing sling with clips Bathing sling with clips</p>	<p>Description Description</p>	<p>Guidelines for sling sizes Guideline for sling sizes</p>		
	<p>made of nylon washable at max. 60°C</p>	<p>Size S M L XL XXL</p>	<p>Weight 35-65 kg 55-85 kg 75-125 kg 120-160 kg 160-210 kg</p>	<p>Color red yellow green blue orange</p>
<p>Toilet sling with clips Toilet sling with clips</p>	<p>Description Description</p>	<p>Guidelines for sling sizes Guideline for sling sizes</p>		
	<p>made of nylon washable at max. 60°C</p>	<p>Size S M L XL XXL</p>	<p>Weight 35-65 kg 55-85 kg 75-125 kg 120-160 kg 160-210 kg</p>	<p>Color red yellow green blue orange</p>
<p>Sling with clips for double leg amputees Sling with clips for double leg amputees</p>	<p>Description Description</p>	<p>Guidelines for sling sizes Guideline for sling sizes</p>		
	<p>made of nylon with head support and safety clip system, washable at 60 ° C, suitable for 4-point suspension</p>	<p>Size S M L XL XXL</p>	<p>Weight 35-65 kg 55-85 kg 75-125 kg 120-160 kg 160-210 kg</p>	<p>Color red yellow green blue orange</p>

## 18. Mounting instructions

### 18.1 Rear Castor Replacement

#### Image 1:

##### Required tools:

1 x 10 mm Allen wrench



#### Image 2:

##### Additional parts/tools:

1 x rear castor (Order number S9200130)  
1 x thread lock fluid (medium tight)



#### Image 3:

Put an object (e.g. wooden block) under the side where you want to replace the castor to free the castor.



#### Image 4:

Unscrew the screw of the castor using the Allen wrench.

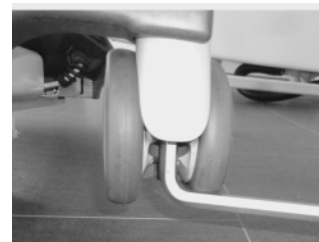

#### Image 5:

Remove the screw of the castor. Hold the castor back with your hand! Remove the castor with the screw



#### Image 6:

Remove the cover plate with thread and fixing pins. Caution, the fixing pins are loose. Make sure you do not lose a fixing pin!

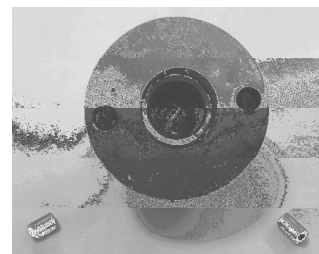

#### Image 7:

Prior to screwing a new castor, you must apply thread lock fluid (medium tight at least 21 Nm) to the thread of the screw.



**Caution: the thread lock fluid must dry at least 3 hours before the device can be loaded. Should you use thread lock fluid from another manufacturer, the drying times specified by this manufacturer must be observed!**

**Re-assemble in reversed order!**

## 18.2 Front Castor Replacement

### Image 1:

#### Required tools:

1 x 10 mm Allen wrench



### Image 2:

#### Additional parts/tools:

1 x front castor  
(Order number S9200350)  
1 x thread lock fluid  
(medium tight)



### Image 3:

Put an object (e.g. wooden block) under the side where you want to replace the castor to free the castor.

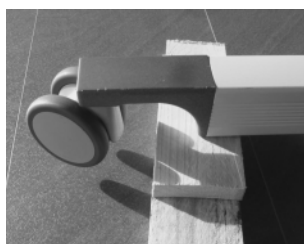

### Image 4:

Unscrew the screw of the castor using the Allen wrench.

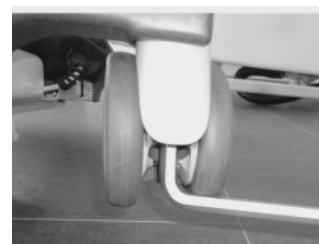

### Image 5:

Remove the screw of the castor. Hold the castor back with your hand!  
Remove the castor with the screw



### Image 6:

Prior to screwing a new castor, you must apply thread lock fluid (**medium tight at least 21 Nm**) to the thread of the screw.



**Caution: the thread lock fluid must dry at least 3 hours before the device can be loaded. Should you use thread lock fluid from another manufacturer, the drying times specified by this manufacturer must be observed!**

**Re-assemble in reversed order!**



### 18.3 Control including Handle, Mounting Plate and Battery Compartment

**Image 1:**

Required tools:  
 1 x 4 mm T-handle  
 1 x 4 mm Allen wrench



**Image 2**

Tool for the battery mounting plate:  
 1 x 2.5mm T-handle  
 1 x 4mm T-handle



**Image 3:**

Remove the battery from the battery compartment



**Image 4:**

Unscrew and remove the left-hand screw of the handle in the mounting plate.



**Image 5:**

Unscrew and remove the right-hand screw of the handle in the mounting plate.



**Image 6:**

The image shows the mounting plate with the right-hand screw removed from the handle.



**Image 7:**

The image shows the mounting plate with the left-hand screw removed from the handle.

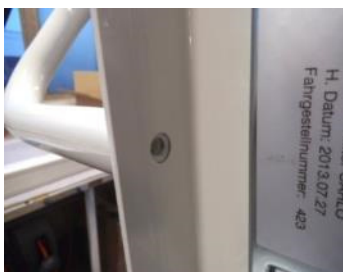
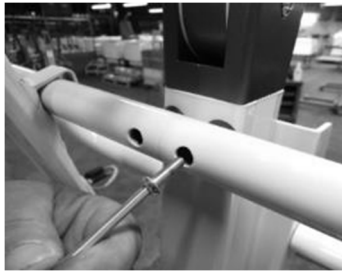

**Image 8:**

Unscrew the front right-hand screw from the handle.



**Image 9:**  
Remove the front right-hand screw from the handle.



**Image 10:**  
Unscrew the front left-hand screw from the handle.



**Image 11:**  
Remove the front left-hand screw from the handle.



**Image 12:**  
Remove the diode plug of the handset from the control box.



**Image 13:**  
Remove the jack plug of the lifting motor from the control box.



**Image 14:**  
Remove the jack plug of the spreading motor from the control box.



**Image 15:**  
Unscrew and remove the locking screw of the control box and remove the control box.



**Image 16:**  
Unscrew and remove the top locking screw from the battery compartment.



**Image 17:**  
Unscrew and remove the middle locking screw from the battery compartment.



**Image 18:**  
Unscrew and remove the bottom locking screw from the battery compartment.



**Image 19:**  
Remove the battery compartment from the mounting plate.



**Image 20:**  
Unscrew and remove the two top locking screws from the mounting plate.



**Image 21:**  
Unscrew and remove the two bottom locking screws from the mounting plate.



**Image 22:**  
Remove the mounting plate.



Re-assemble in reversed order!

## 18.4 Replacing the Battery

**Image 1:**  
The image shows the inserted battery.



**Image 2:**  
Unlock the battery by means of the release lever in the battery handle.



**Image 3:**  
You can lift the battery up to remove it.

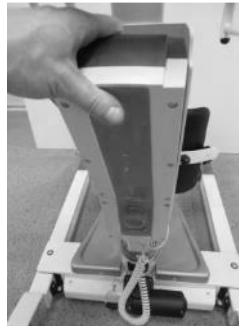

**Image 4:**  
The image shows the removed battery. When replacing the battery, please check that the release lever engages audibly.





**Distributed by:**

# PRISM MEDICAL



485 Millway Ave. Concord Ont. L4K 3V4 | T 1.800.265.0677 | F 416.260.5580 |  
[www.prismmedical.ca](http://www.prismmedical.ca)

